

5

4

3

2

1

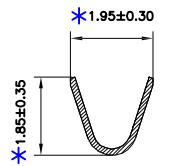
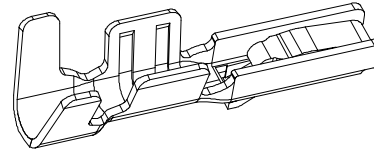
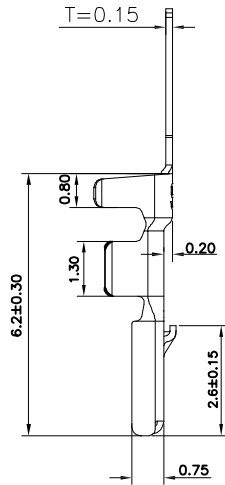
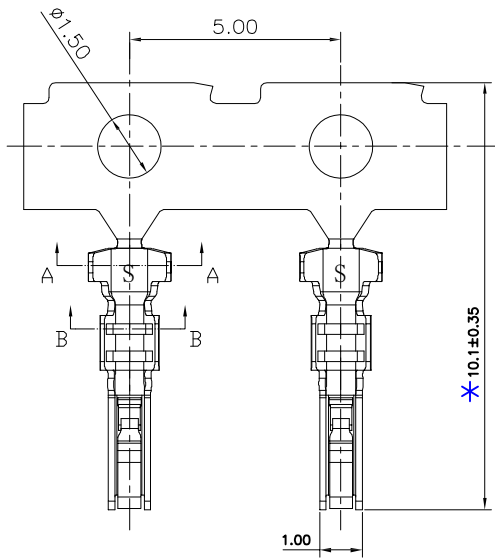

SECTION A-A
SCALE 1:1

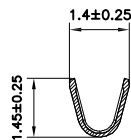

SECTION B-B
SCALE 1:1

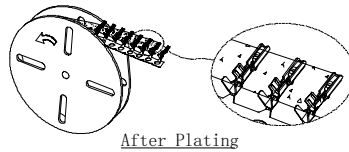

■ Specifications :

- Voltage rating: 125V AC / DC
- Current rating: 2A AC / DC
- Withstanding voltage: 800V AC/minute
- Temperature range: -40°C~+105°C
- Insulation resistance: $\geq 500M\Omega$
- Contact resistance: $\leq 20m\Omega$
- After environmental testing: $\leq 40m\Omega$

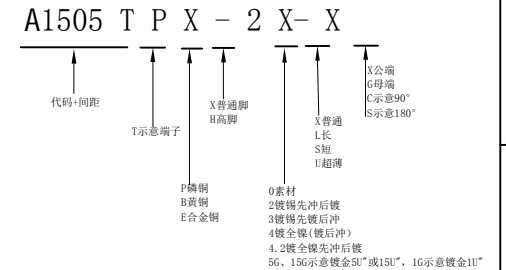

东莞市平达电子科技有限公司

				料号PART NO: A1505TPX-2X-G				一般公差 GENERAL TOLERANCE	
				品名 TITLE: 1505-T				X.X ±0.30	
				材料:		单位: MM		X.XX ±0.25	
				包装规格:		比例: 1:1		ANGLE ±1°	
日期版次 REVISION		日期 DATE		变更内容 DESCRIPTION		核 准 APPROVALBY		制图:	
								日期: 2021.10.25	

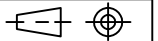

PD

6

5

4

3

2

1